

TECHNICAL BULLETIN

N 89 - 2020. 12

ES38



- New narrow triple rail (glaz. – fly screen – shutter)
- New anodized rail

content:

■ PROFILES
■ PROFILES 1:1

■ DETAILS
■

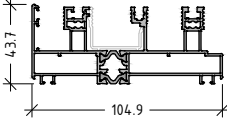
ETEM

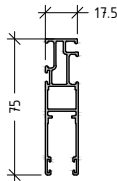
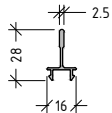
code	Profile	Weight Length Moment of inertia	code	Profile	Weight Length Moment of inertia
E53108	 <p>Narrow triple rail Στενός οδηγός για τζάμι-σήτα-παντζούρι</p>	1975 g/m L=6.01 m			
E62009	 <p>Anodized rail Ανοδωμένος οδηγός</p>	111 g/m L=6.01 m			
E36220	 <p>Fly screen sash Φύλλο σήτας</p>	753 g/m L=6.01 m			
E32615	 <p>Adjoining profile for E36220 Μπινί για φύλλο σήτας</p>	194 g/m L=6.01 m			

E53108

Triple rail
(glazing-fly
screen-shutter)

Οδηγός για τζάμι-
σήτα-παντζούρι

1975 gr/m

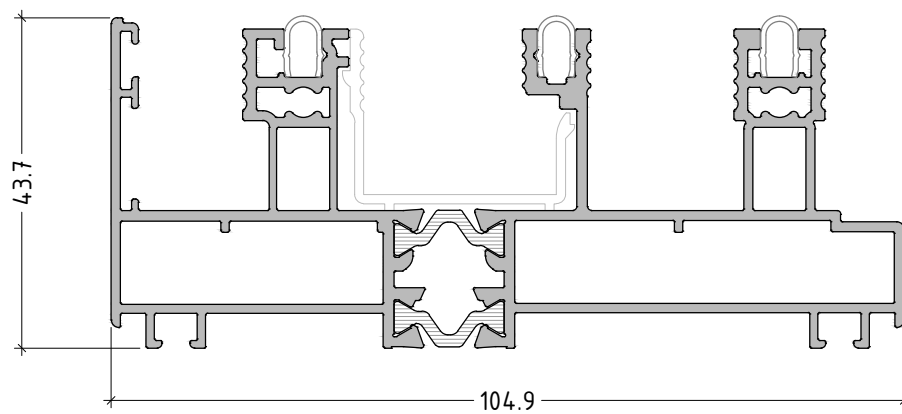

scale : 1:1

E62009

Anodized rail
Ανοδιωμένος
οδηγός

111 gr/m

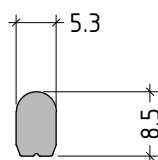

ALTERNATIVE
ΕΝΑΛΛΑΚΤΙΚΑ

ANODIZED RAIL E62009
ΑΝΟΔΙΩΜΕΝΟΣ ΟΔΗΓΟΣ
E62009

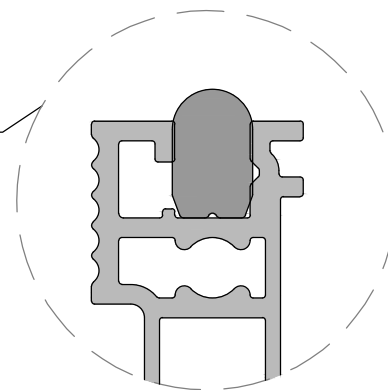
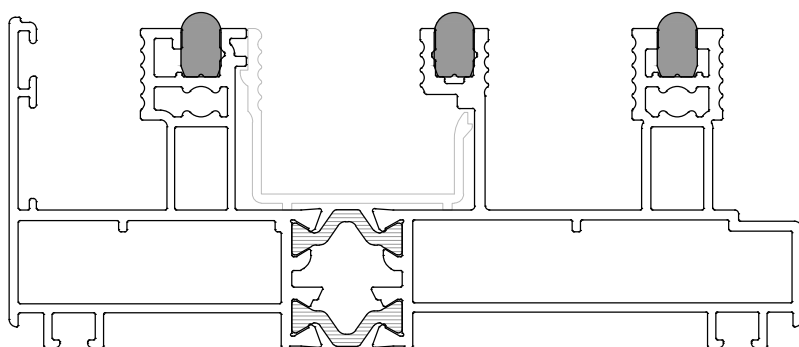

scale : 1:1

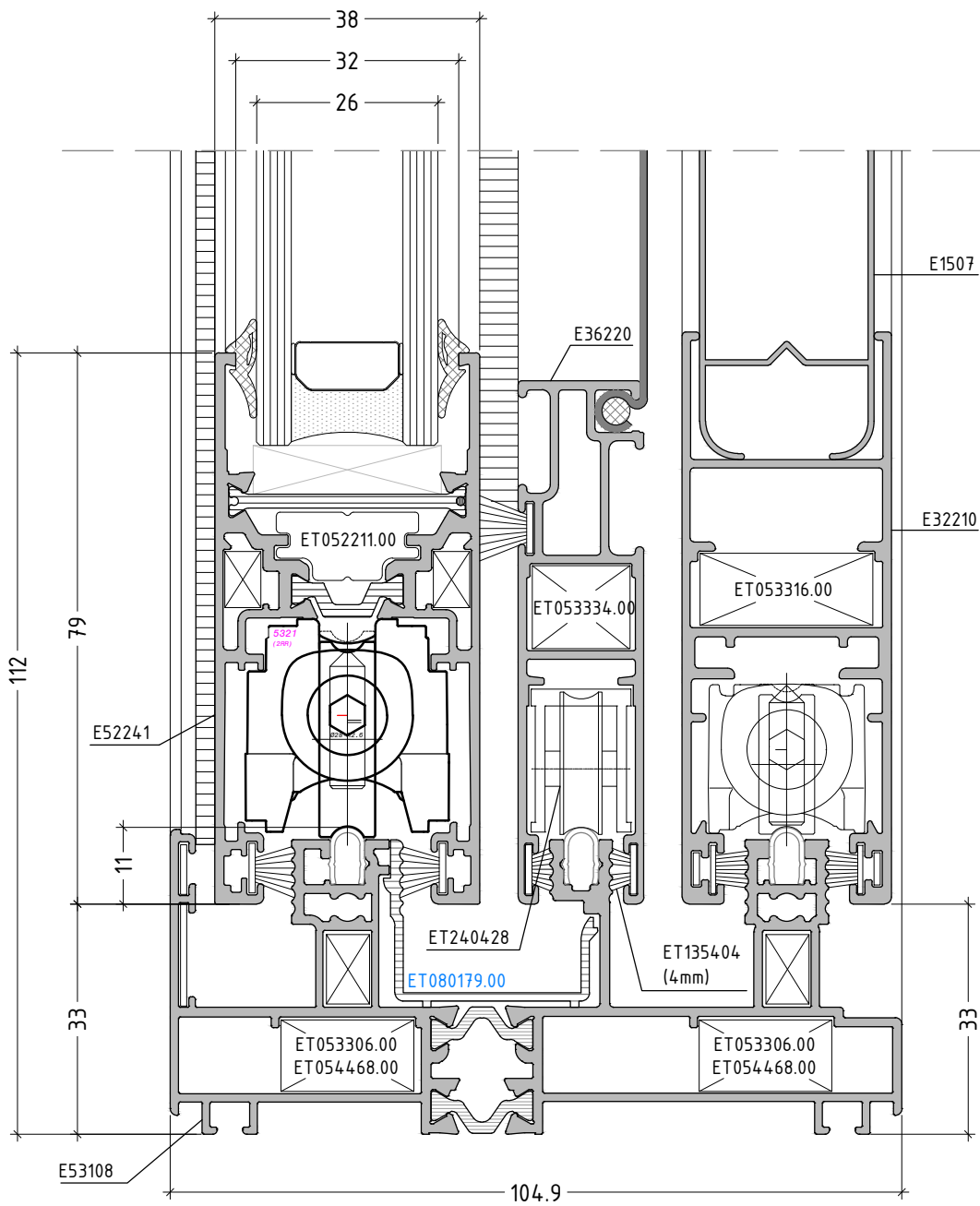
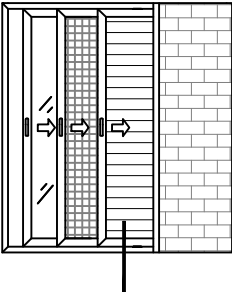

scale : 1:1

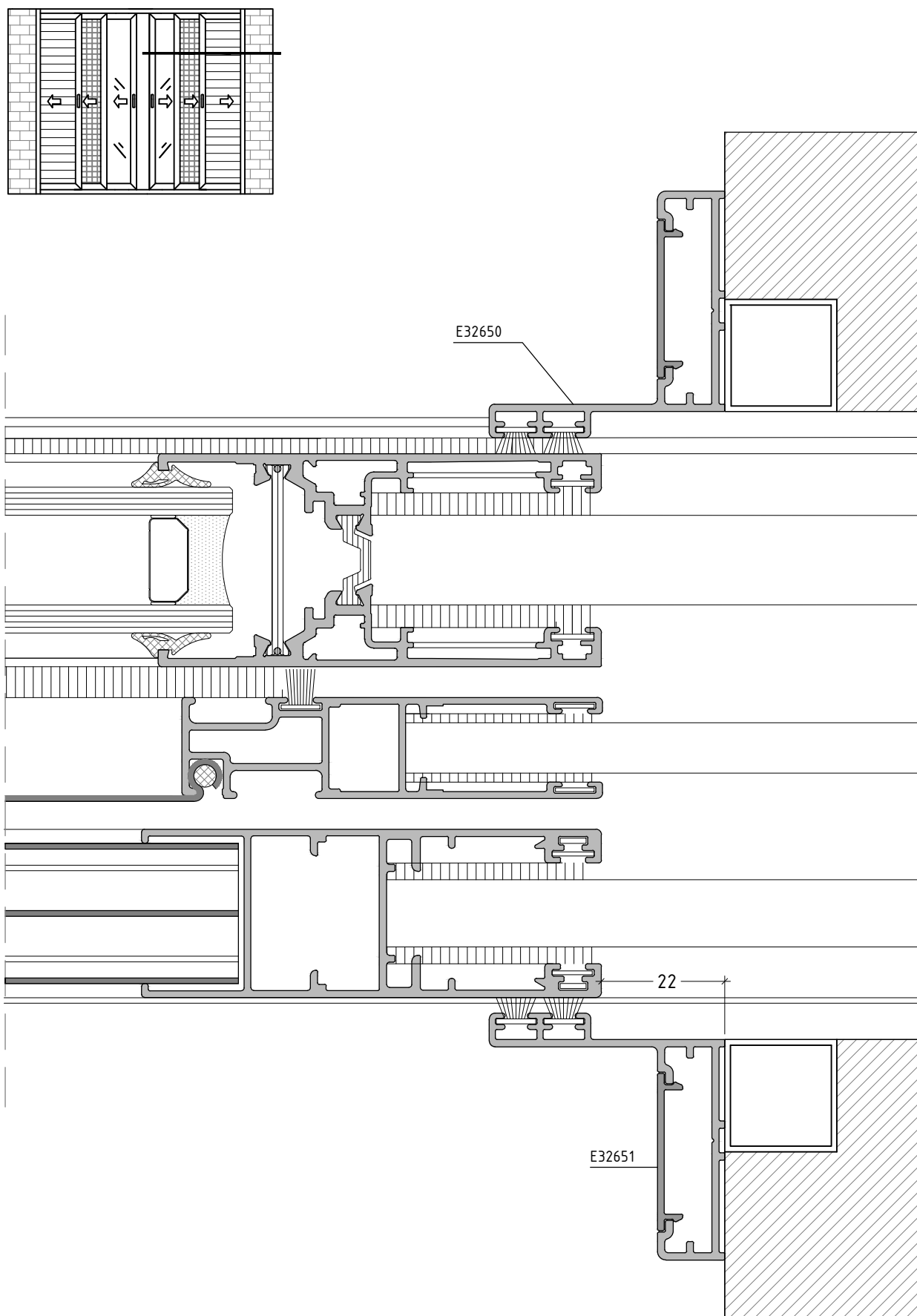

scale : 1:1

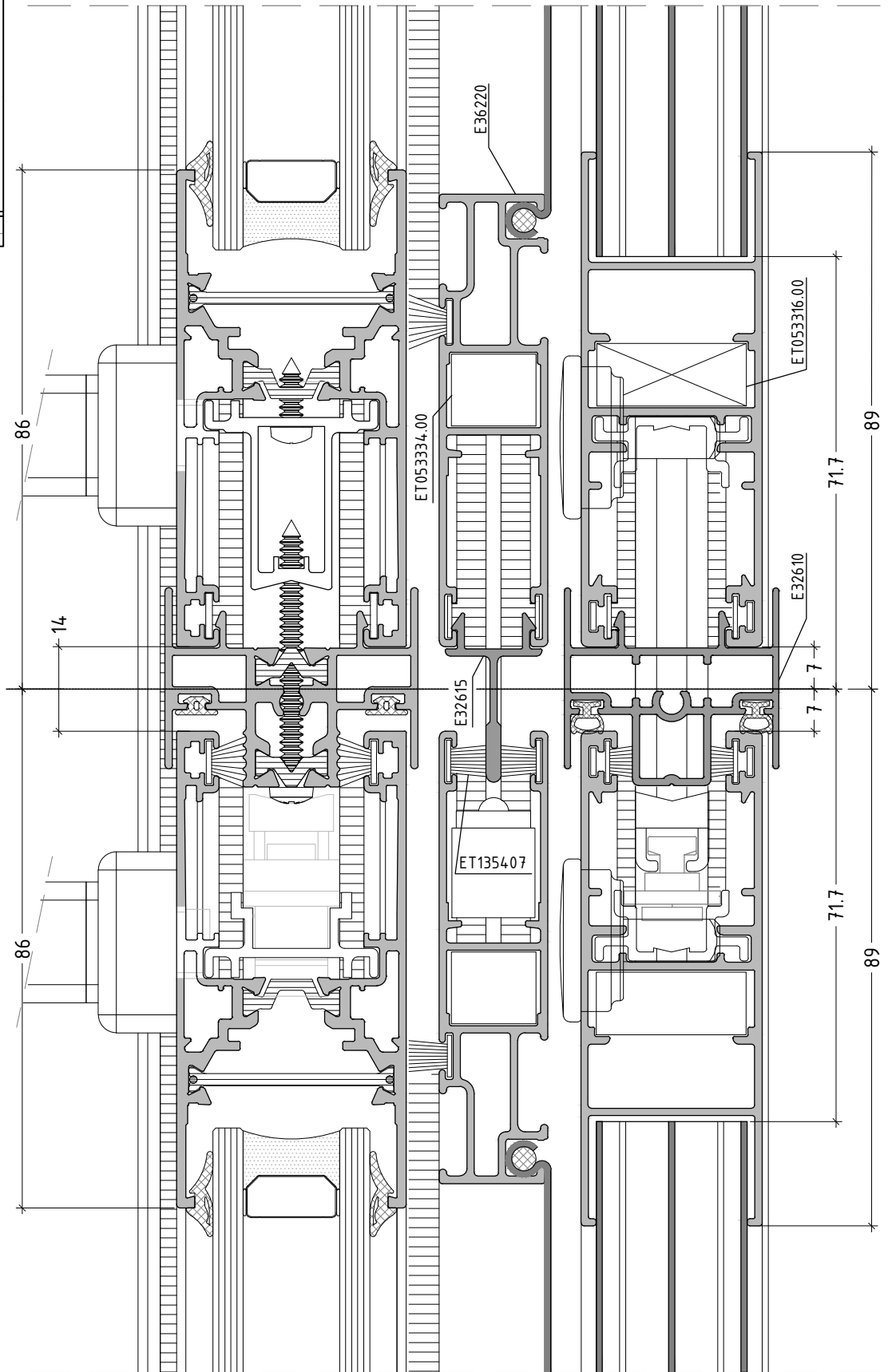
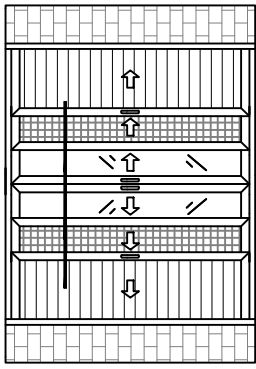

scale : 1:1

NEW STOPPER ET.240642.02, 18.5mm

NEO ΣΤΟΠΕΡ ET.240642.02, 18.5mm

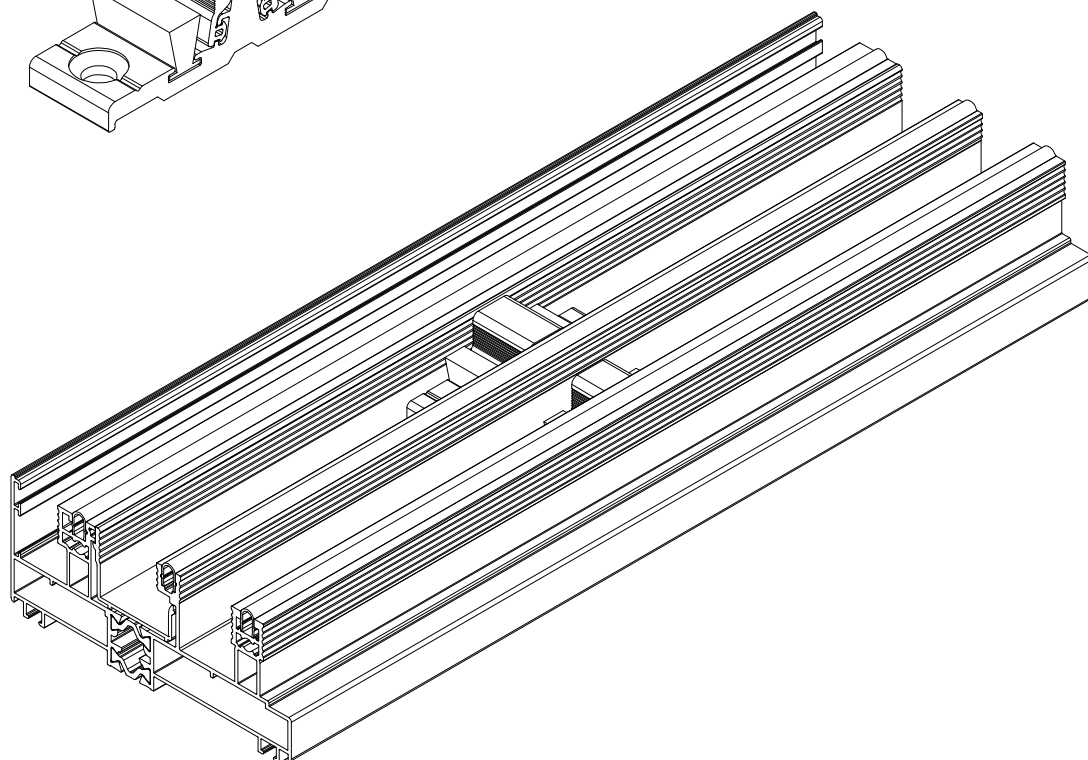
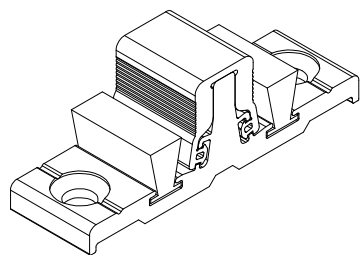

ET.240642.02

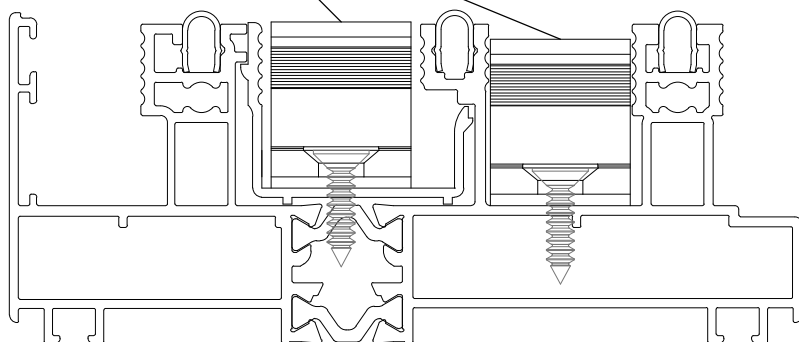

scale : 1:1