

Technical Bulletin № 54 -2015.06

New standard profiles for sliding

1. Tables
2. Profiles
3. Sections
4. Cutting lists
5. Accessories

standard profiles for sliding



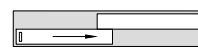
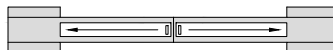
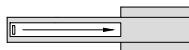
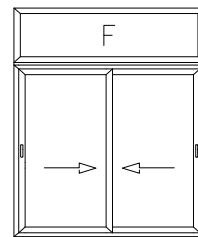
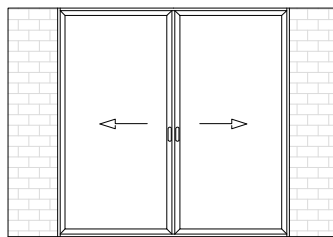
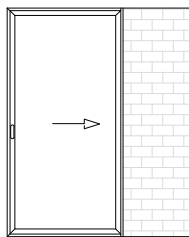
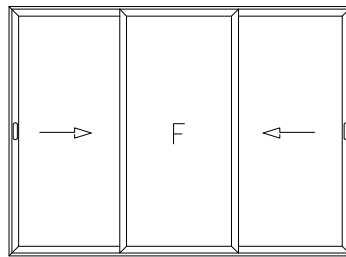
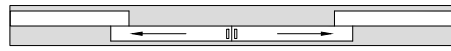
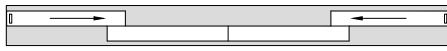
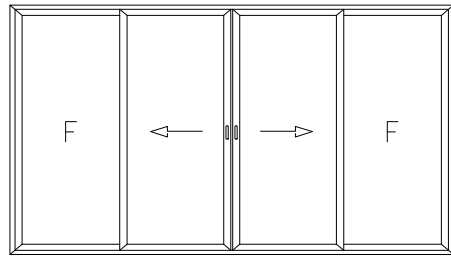
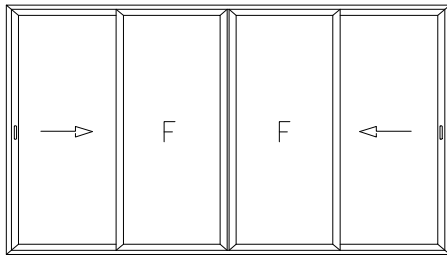
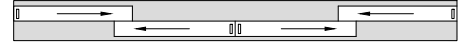
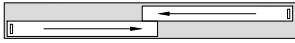
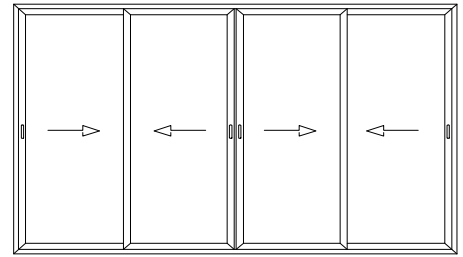
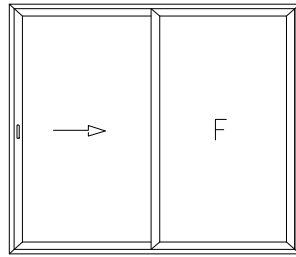
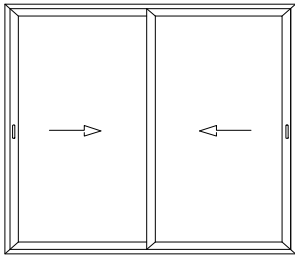

-



G16xxx-01

standard profiles for sliding

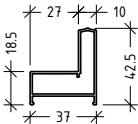
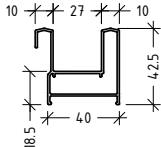
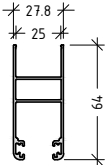
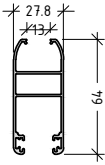
-

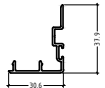
code		profile	weight length moment of inertia	code		profile	weight length moment of inertia
41604			505 g/m L=6.01 m				
41605			662 g/m L=6.01 m				
41602			691 g/m L=6.01 m				
41601			716 g/m L=6.01 m				
41606			167 g/m L=6.01 m				
41603			297 g/m L=6.01 m				

L16xxx-01

standard profiles for sliding

-

41604
505 g/m

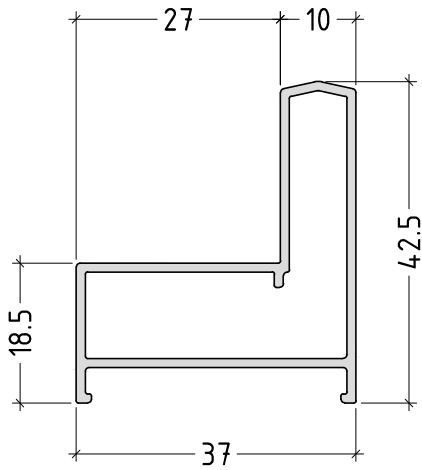

41605
662 g/m

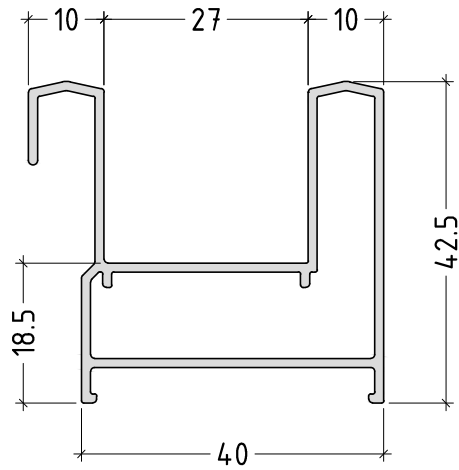

41602
691 g/m

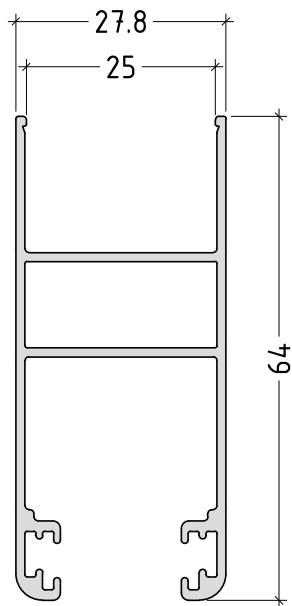

41601
716 g/m

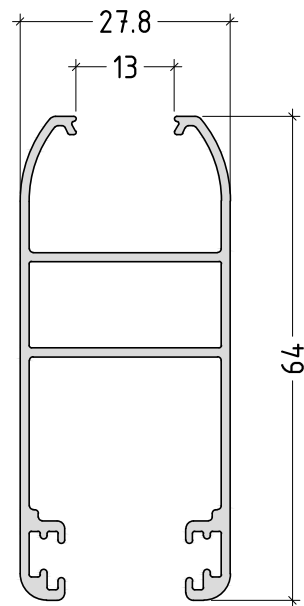

scale : 1:1

P16xxx-01

standard profiles for sliding

-

41606
167 g/m

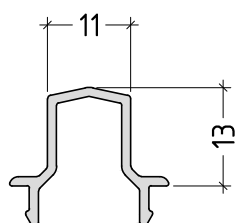

41603
297 g/m

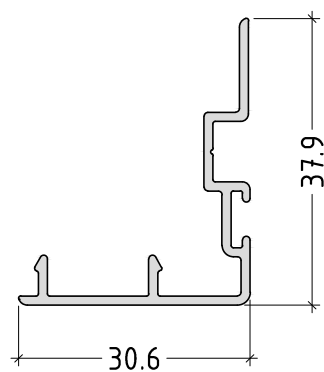

scale : 1:1

standard profiles for sliding

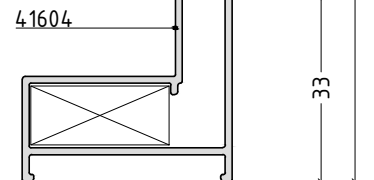
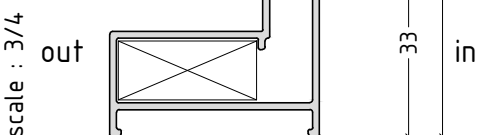
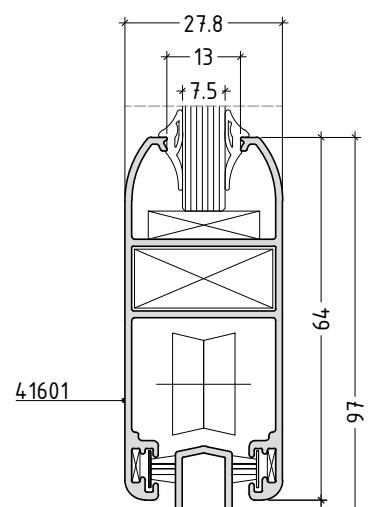
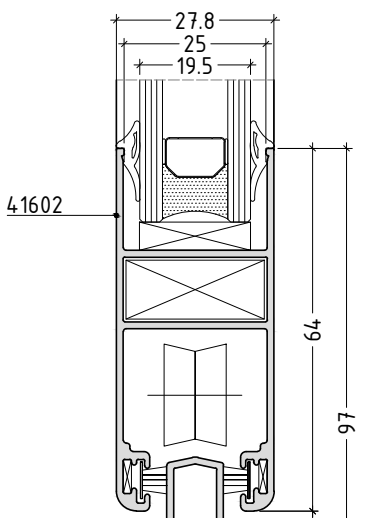
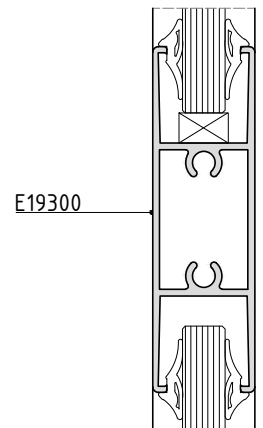
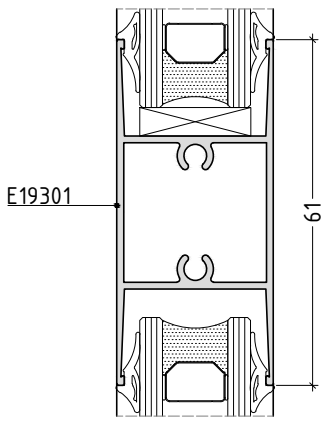
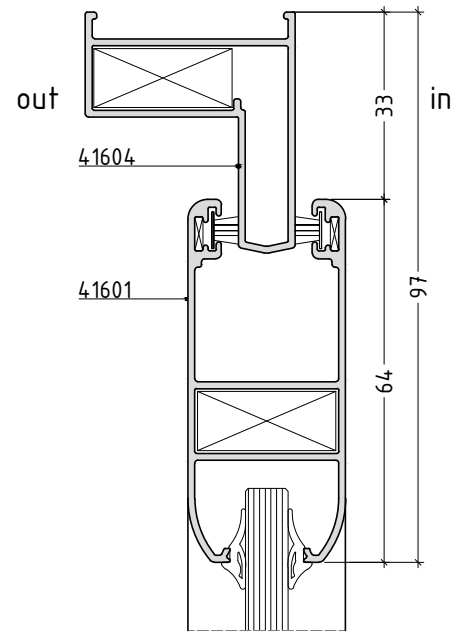
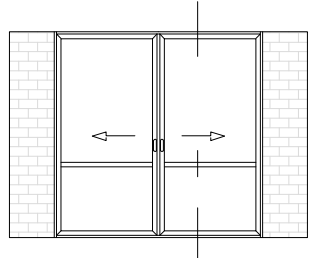
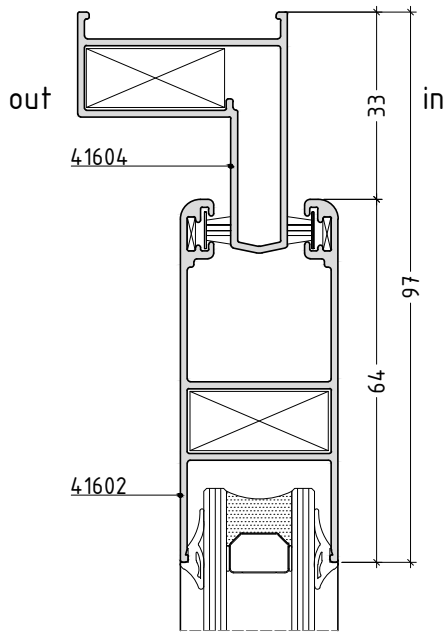

D16xxx-01

standard profiles for sliding

-

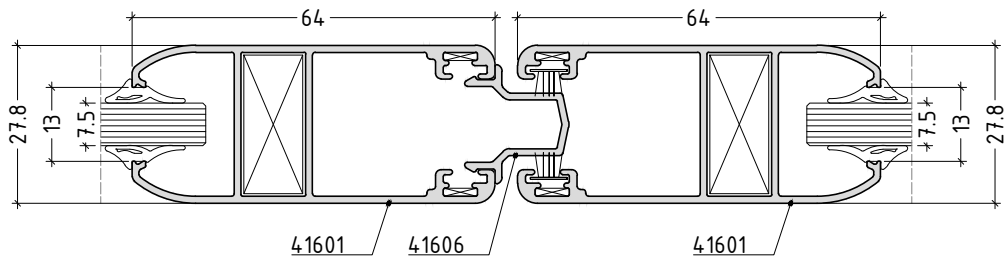
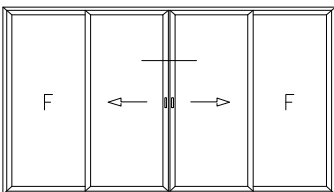
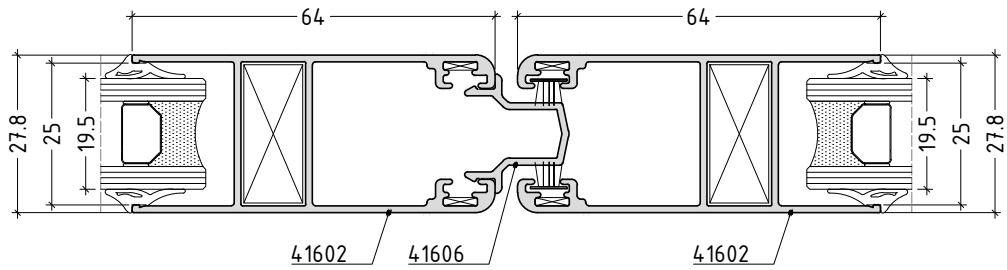
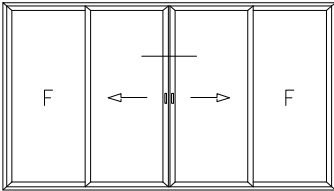

scale : 3/4

standard profiles for sliding

-

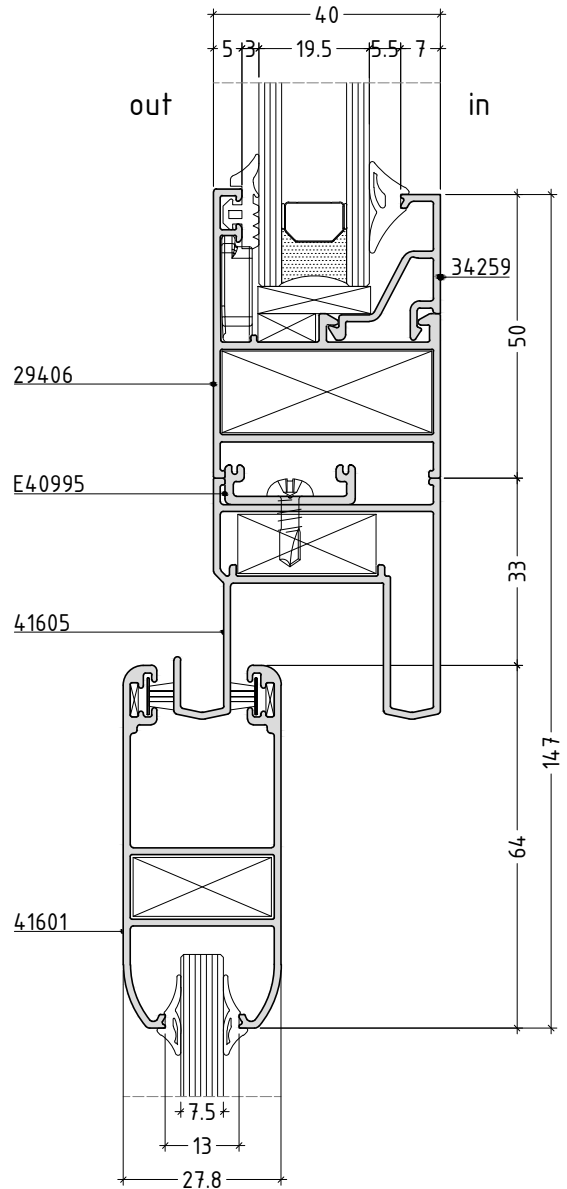
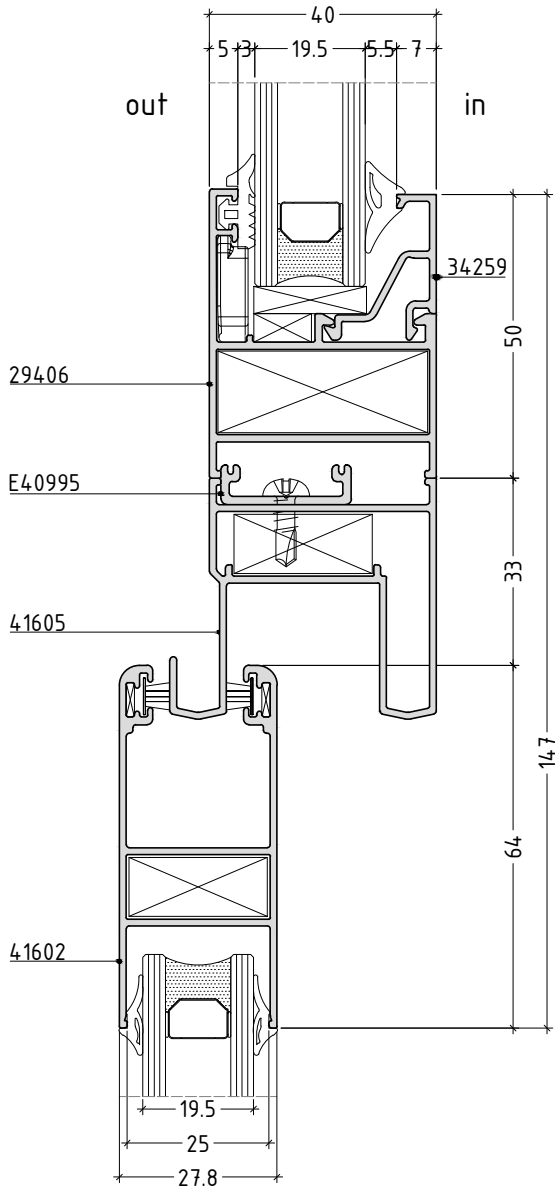
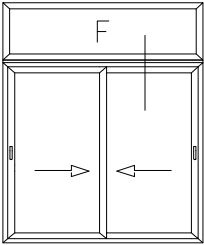

scale : 3/4

D16xxx-03

standard profiles for sliding

-

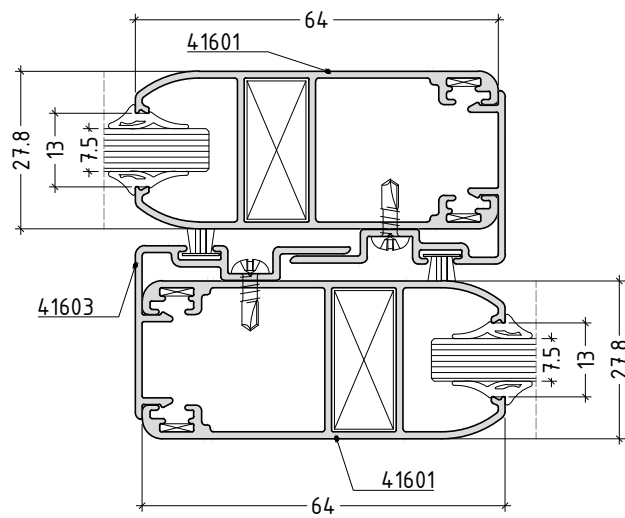
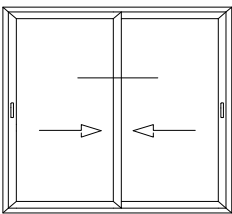
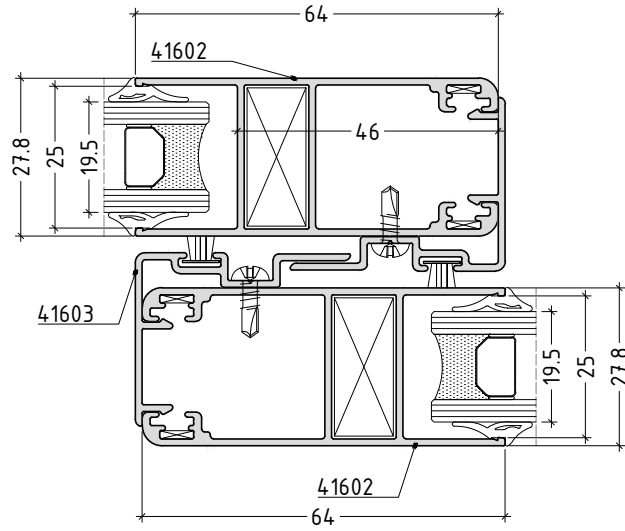
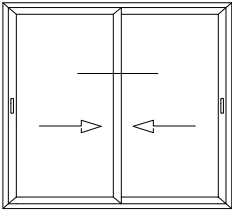

scale : 3/4

cutting list for double glazing

		calculation of cutting length		
profile selection		pieces	cutting formula	cutting angles
41605 	width of frame	2	W	2x45°
	height of frame	2	H	2x45°
41602 	width of sash	4	$\frac{W - 3}{2}$	2x45°
	height of sash	4	H - 66	2x45°
41603 	height of 41603	2	H - 66	2x90°
option 1				
E19301 	width of E19301	2	W1 - 93	2x90°



cutting list for single glazing

		calculation of cutting length		
profile selection		pieces	cutting formula	cutting angles
41605 	width of frame	2	W	2x45°
	height of frame	2	H	2x45°
41601 	width of sash	4	$\frac{W - 3}{2}$	2x45°
	height of sash	4	H - 66	2x45°
41603 	height of 41603	2	H - 66	2x90°
option 1				
E19300 	width of E19300	2	W1 - 93	2x90°

standard profiles for sliding

-

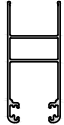
cutting list for double glazing

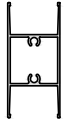
profile selection		pieces	cutting formula	cutting angles
41605 	width of frame	2	W	2x45°
	height of frame	2	H	2x45°
41602 	width of sash	8	$\frac{W + 55.6}{4}$	2x45°
	height of sash	8	H - 66	2x45°
41603 	height of 41603	4	H - 66	2x90°
41606 	height of 41606	1	H - 66	2x90°
option 1				
E19301 	width of E19301	4	W1 - 93	2x90°



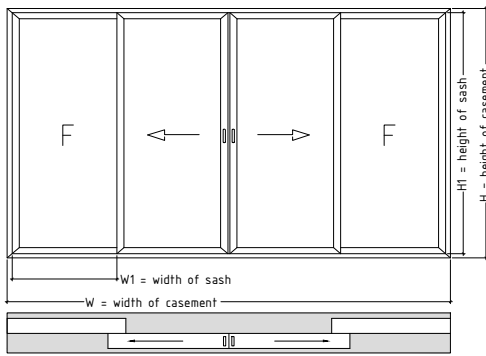

calculation of cutting length

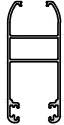

standard profiles for sliding

-

cutting list for single glazing

profile selection		pieces	cutting formula	cutting angles
41605 	width of frame	2	W	2x45°
	height of frame	2	H	2x45°
41601 	width of sash	8	$\frac{W + 55.6}{4}$	2x45°
	height of sash	8	H - 66	2x45°
41603 	height of 41603	4	H - 66	2x90°
41606 	height of 41606	1	H - 66	2x90°
option 1				
E19300 	width of E19300	4	W1 - 93	2x90°

calculation of cutting length

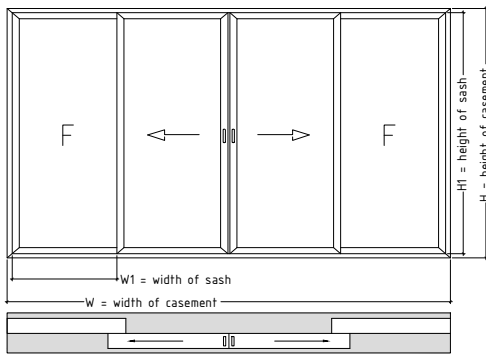

standard profiles for sliding

-

code/description	package/pcs	colour
ET 053305.00	250	MF

die cust al. joint corner bracket

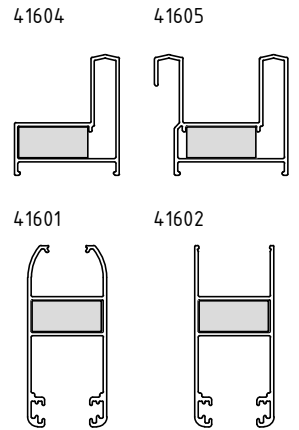
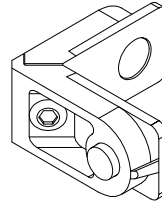

ET 055504.00	200	MF
--------------	-----	----

alignment square 6x1,25

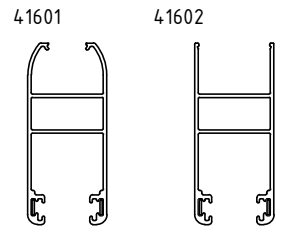
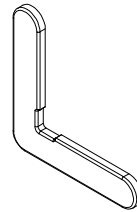

ET 240406.00	100	MF
--------------	-----	----

single roller

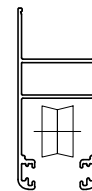

ET 240405.00	100	MF
--------------	-----	----

double roller



A16xxx-01

standard profiles for sliding

-

code/description	package/pcs	colour
ET 130204.00	200	●

glazing EPDM gasket
press-in 4 mm



ET 135406.01	200	●
--------------	-----	---

pile weatherseal 4p 6mm

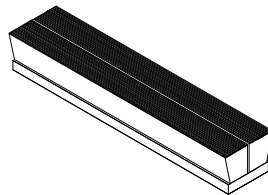

41601

41602

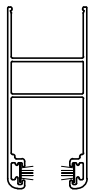

ET 075505.01	50	●
--------------	----	---

anti - dust plug

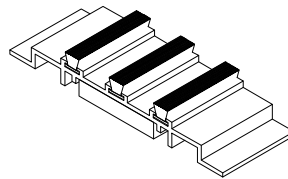

41605

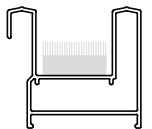

ET 074603.00	100	●
--------------	-----	---

plastic plug for
interlock profile

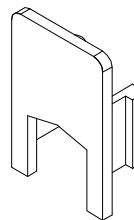

41603

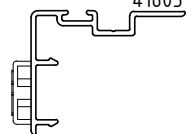

A16xxx-02

standard profiles for sliding

-

code/description	package/pcs	colour
ET 074641.00	10	●

plastic plug for
interlock profile

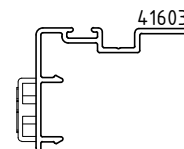
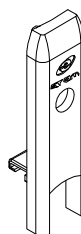

ET 990896.00	100	MF
--------------	-----	----

aluminium stopper



ET 990752.00	100	MF
--------------	-----	----

plastic buffer



ET 995693.01	-	-
--------------	---	---

inserted locking handle
for sliding windows



A16xxx-03